

Terms of Use

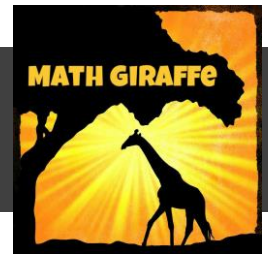

Thanks so much for downloading this file!

This resource is for personal use in your own classroom only. The copyright is owned by Math Giraffe and all rights are reserved.

Permission is granted to copy pages for your own students.

Placing any part of this file anywhere online is a violation of the Digital Millennium Copyright Act.

You may:

- Print this file and distribute it to your students
 - Use it in your own classroom

You may not:

- Upload it on the internet to another site in any form
- Sell it, sell any part of it, or sell anything based upon it
 - Share it without permission

I hope that you and your students enjoy this!

© Copyright 2018 Math Giraffe

Clip Art & Font Credit



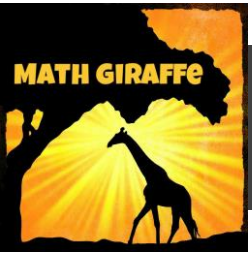

How to Use

By coloring the math tools, students can work toward a treat in the future. Set up a structure where they can slowly earn some kind of reward as a class.

A simple way to do this is by coloring one item in the letters "MATH" each time you determine they have earned one. You can set this up however you want.

Print one set (large size) to hang up on your bulletin board. Choose either the ones with colored borders, or print the black and white option and frame them with a colored background.

You may want an item to get colored only on each day that ALL students submit completed homework. Or you can use it as a reward when a student gets caught doing something great. Say "I love the way you just _____. Go ahead up and color one math symbol on our MATH board."

Once the full word "MATH" is all colored in, the class can earn a reward.

I've also included a mini version for a desk-sized individual option. Each student can work to earn their own reward by coloring it with a special glitter marker you only hand them as you walk around to check daily homework. If they have it complete, you offer the special pen to color one math tool as you authorize it.



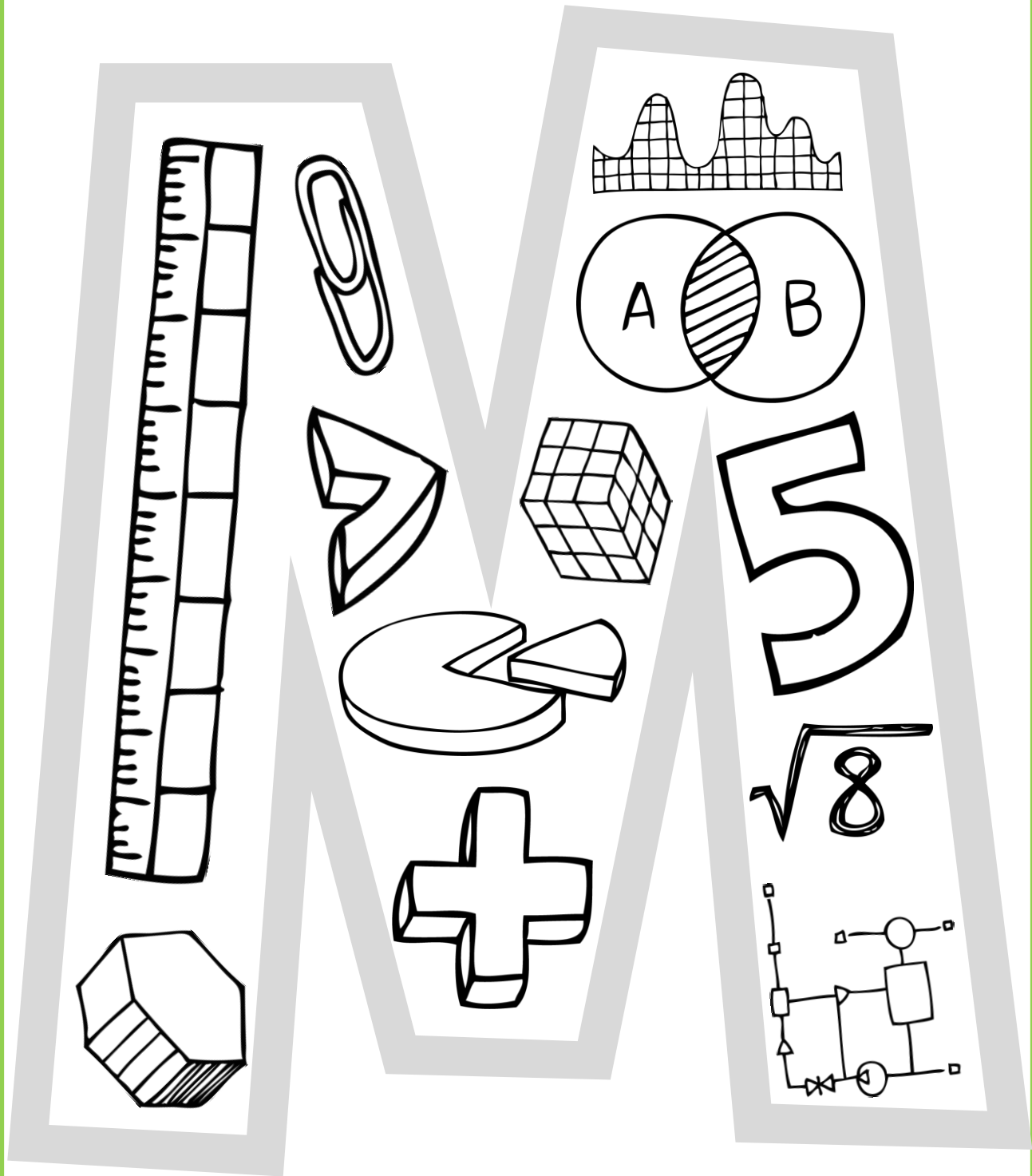

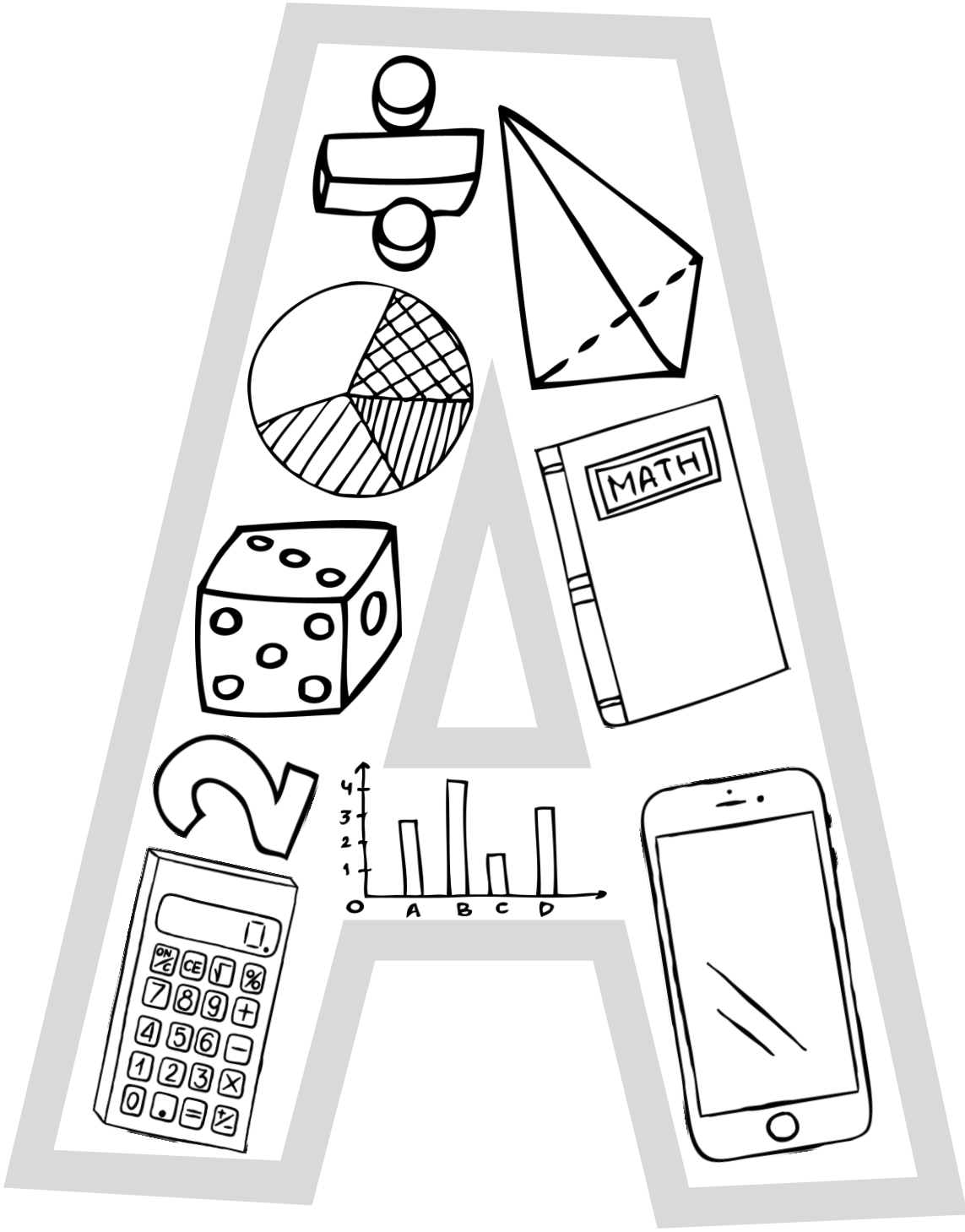

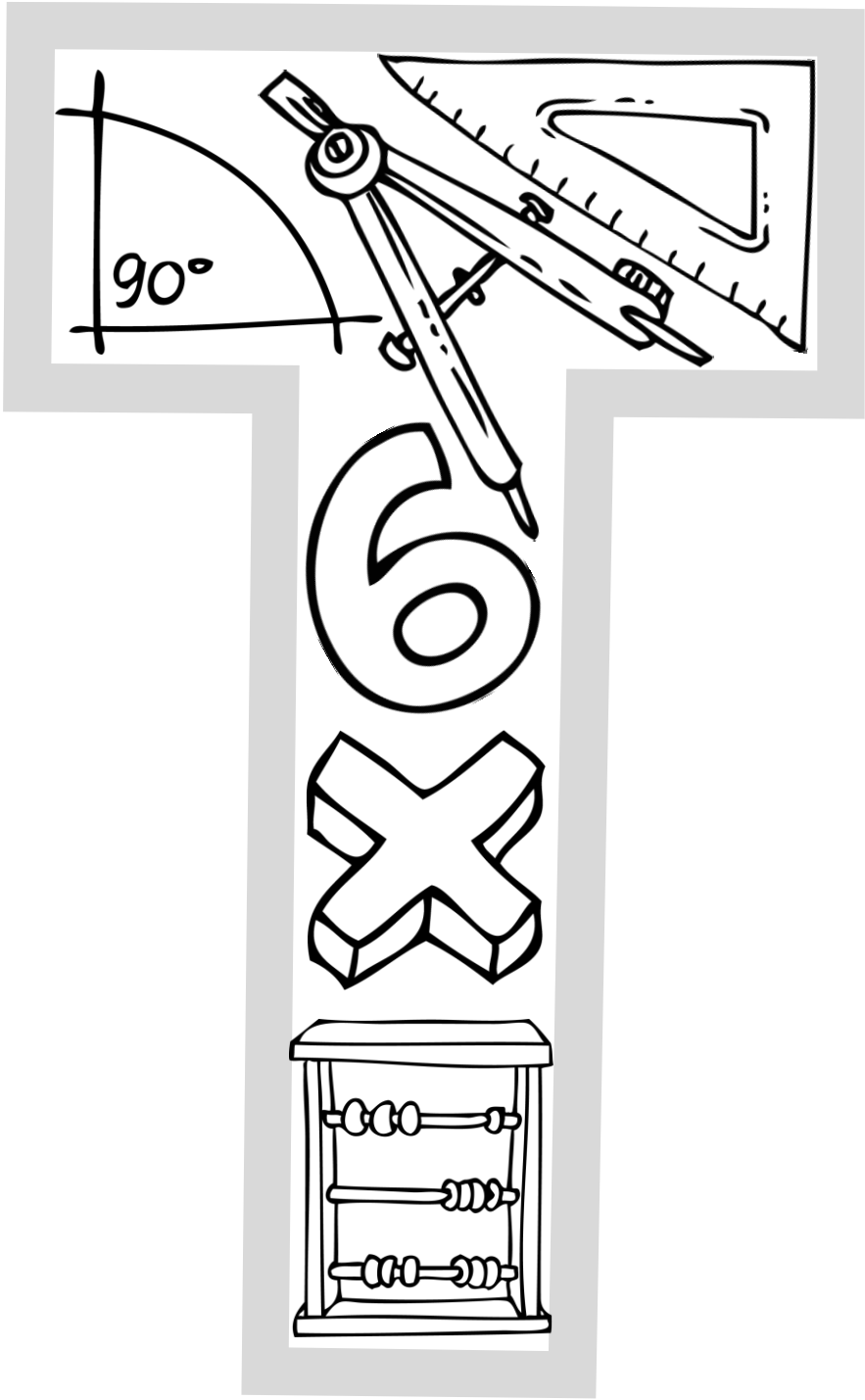

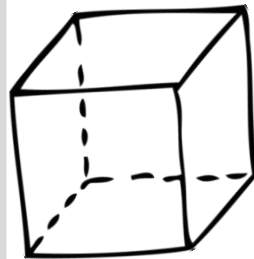
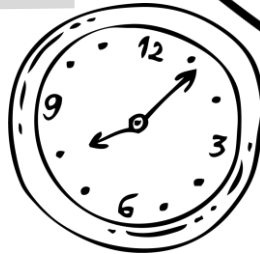
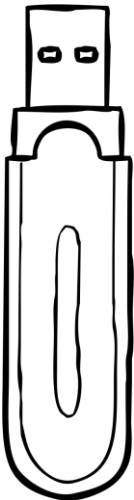
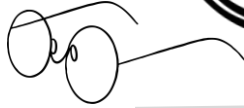
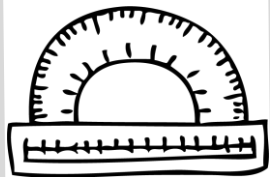
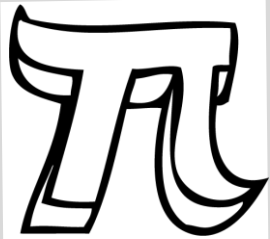

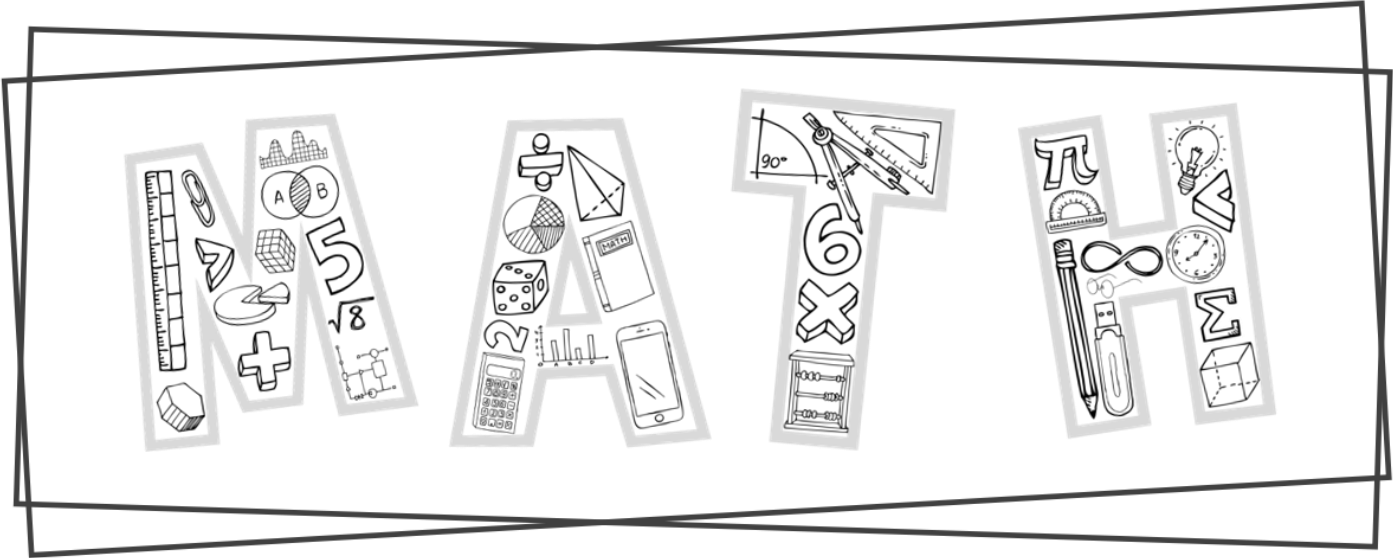
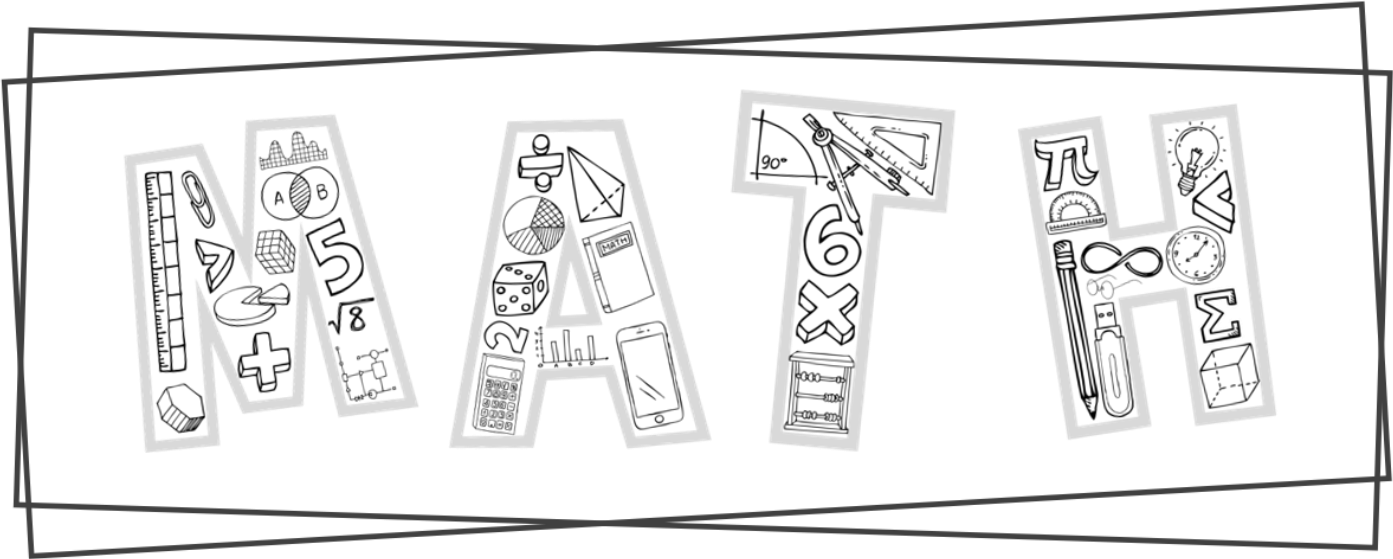
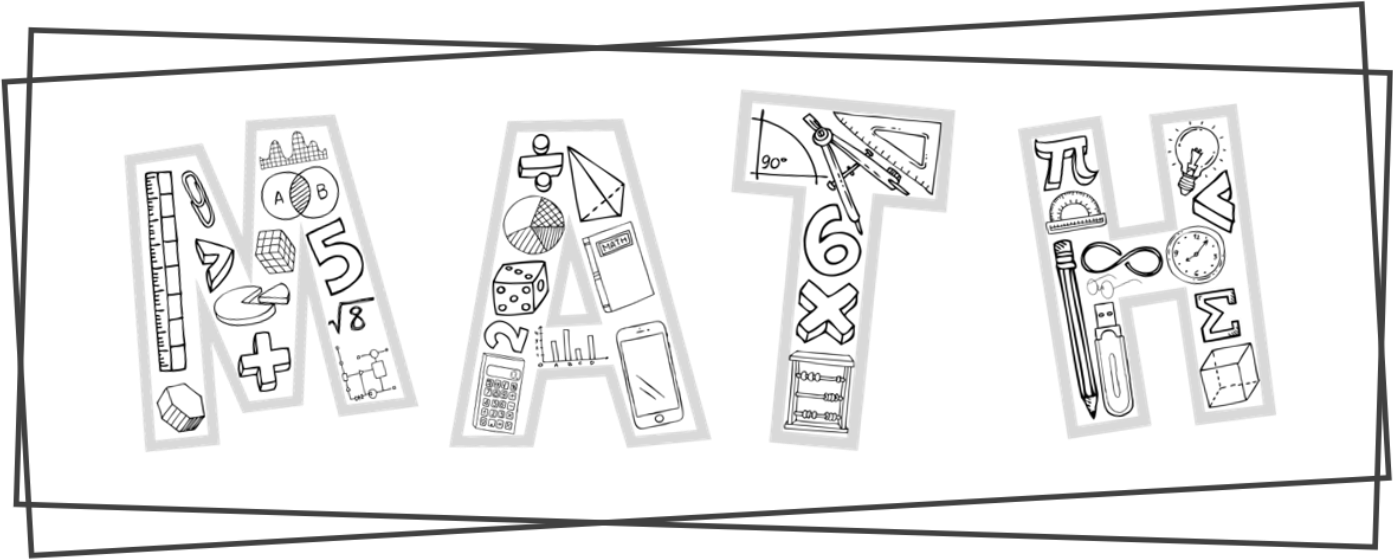

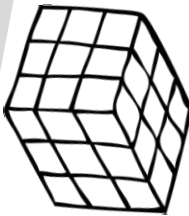
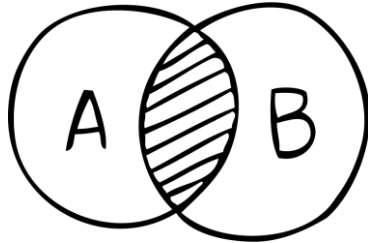
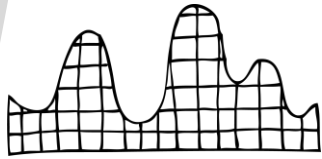
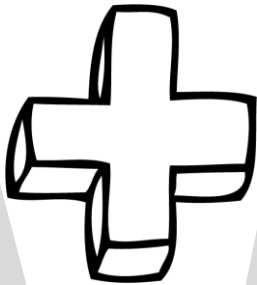
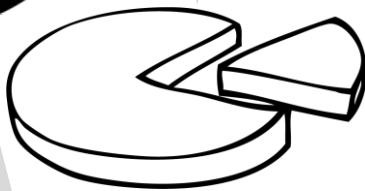
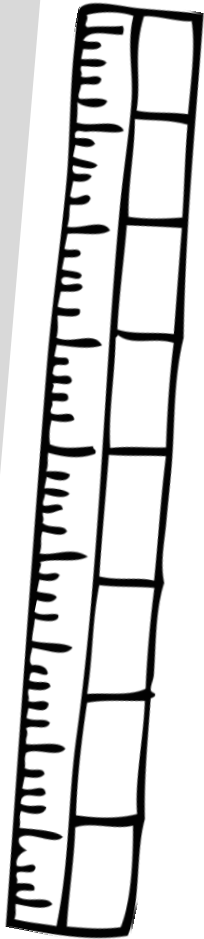
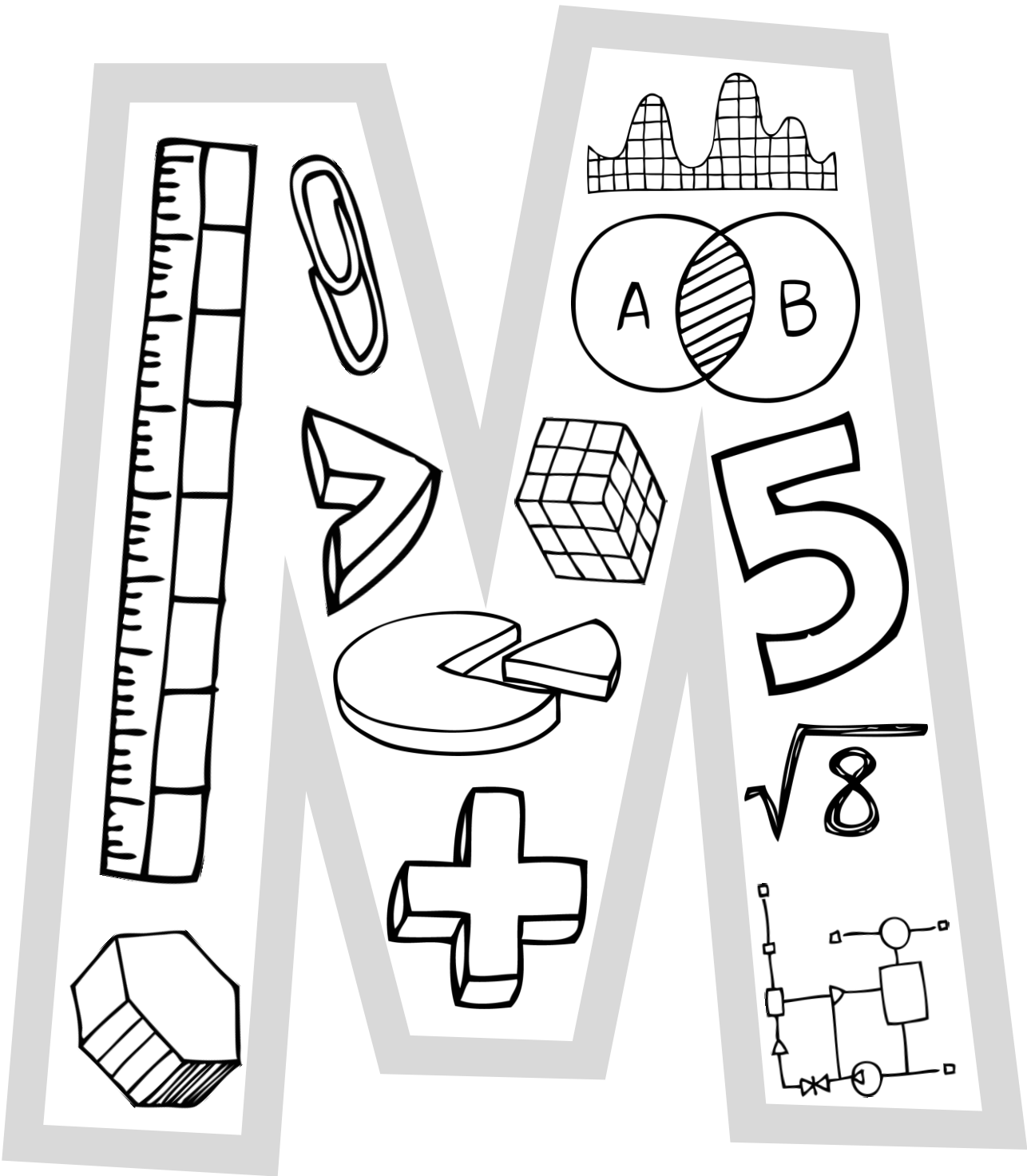

5

$$\sqrt{8}$$

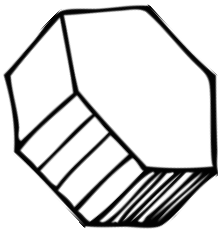
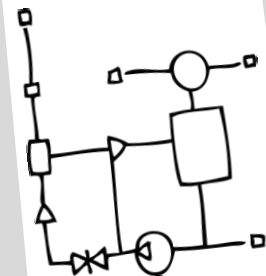

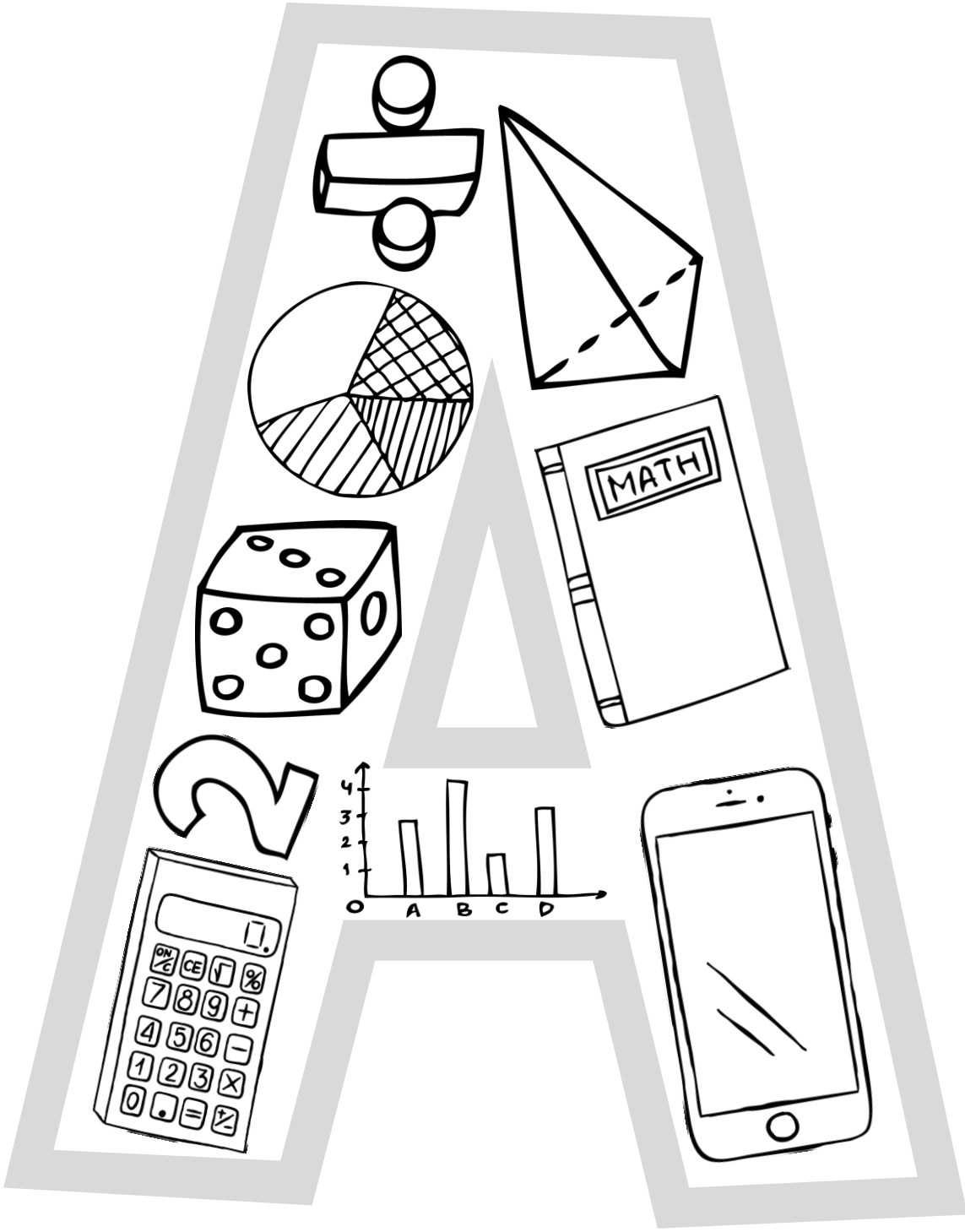

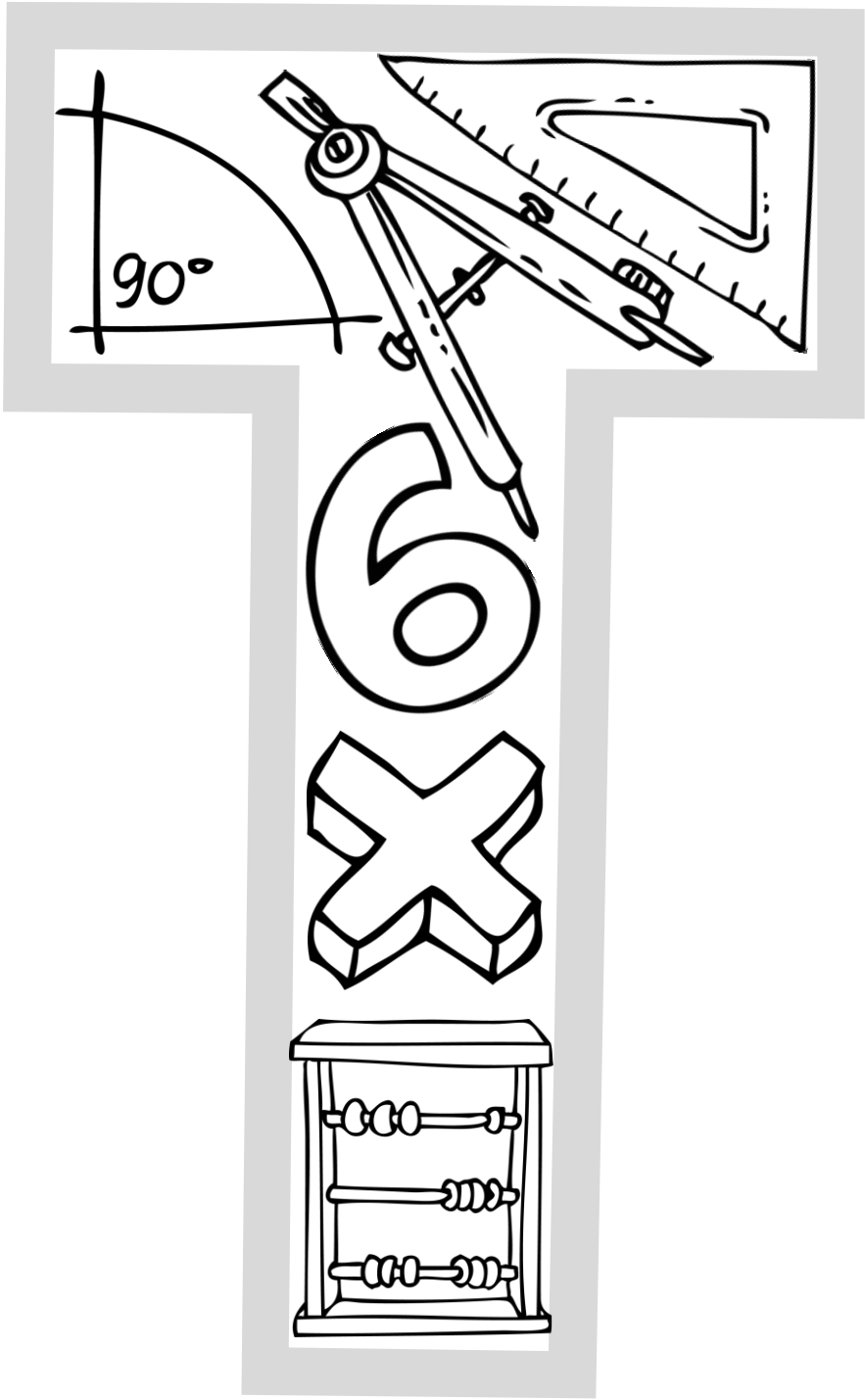

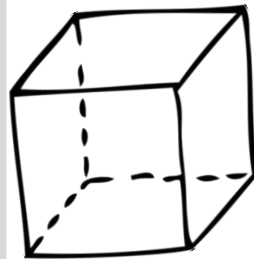
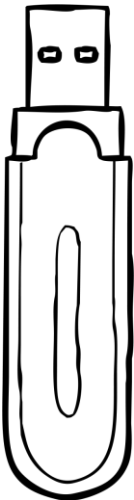
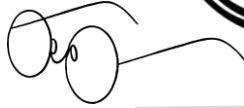
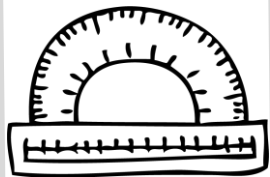
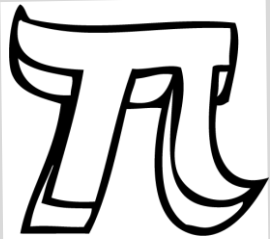

More for Your Class

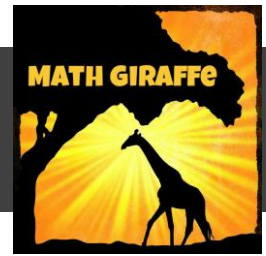

Here are some additional resources and articles to help you get set up for this school year.



Math Skills & Strategies Posters

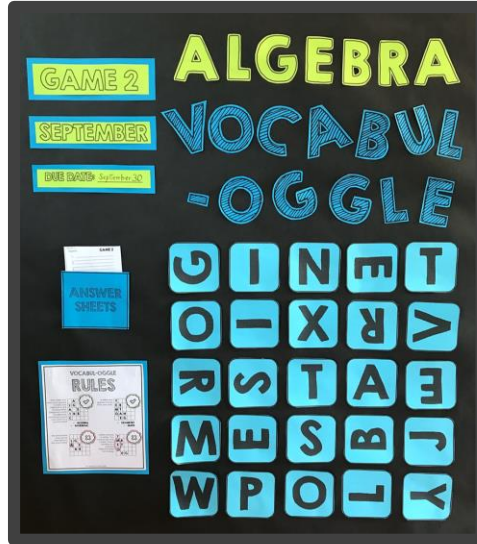

Vocabulary Games



Reading in Math Class

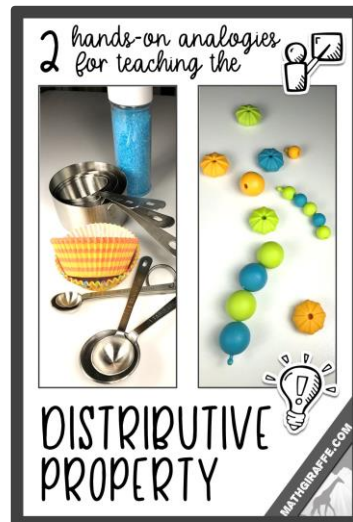
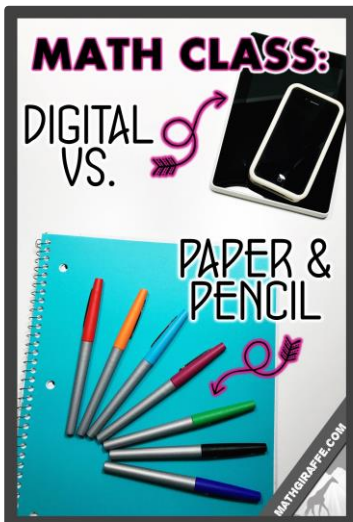

Blog Posts & Articles to Help You This Year

